

RoHS Compliant & Pb-Free Product

Typical Applications

- Narrow and Broadband Commercial and Military Radio Designs
- Linear and Saturated Amplifiers
- Gain Stage or Driver Amplifiers for MWRadio/Optical Designs (PTP/PMP/LMDS/UNII/VSAT/WLAN/Cellular/DWDM)

Product Description

The NBB-400 cascadable broadband InGaP/GaAs MMIC amplifier is a low-cost, high-performance solution for general purpose RF and microwave amplification needs. This 50Ω gain block is based on a reliable HBT proprietary MMIC design, providing unsurpassed performance for small-signal applications. Designed with an external bias resistor, the NBB-400 provides flexibility and stability. The NBB-400 is packaged in a low-cost, surface-mount ceramic package, providing ease of assembly for high-volume tape-and-reel requirements. It is available in either packaged or chip (NBB-400-D) form, where its gold metallization is ideal for hybrid circuit designs.

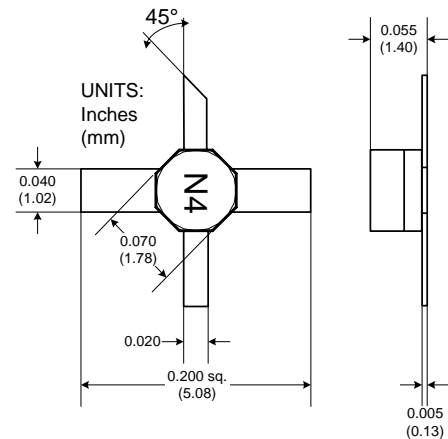

Optimum Technology Matching® Applied

- | | | |
|---|-----------------------------------|---------------------------------------|
| <input type="checkbox"/> Si BJT | <input type="checkbox"/> GaAs HBT | <input type="checkbox"/> GaAs MESFET |
| <input type="checkbox"/> Si Bi-CMOS | <input type="checkbox"/> SiGe HBT | <input type="checkbox"/> Si CMOS |
| <input checked="" type="checkbox"/> InGaP/HBT | <input type="checkbox"/> GaN HEMT | <input type="checkbox"/> SiGe Bi-CMOS |

Package Style: Micro-X, 4-Pin, Ceramic

Features

- Reliable, Low-Cost HBT Design
- 15.5dB Gain, +15.0dBm P1dB @ 2GHz
- High P1dB of +14.6dBm @ 6.0GHz
- Single Power Supply Operation
- 50Ω I/O Matched for High Freq. Use

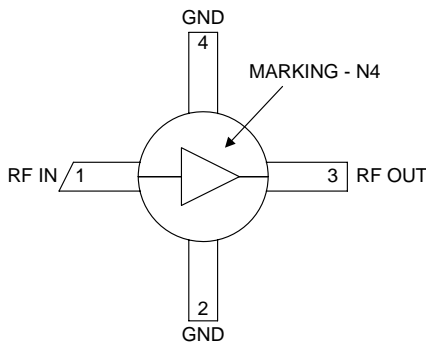

Functional Block Diagram

Ordering Information

| | |
|------------|---|
| NBB-400 | Cascadable Broadband GaAs MMIC Amplifier DC to 8GHz |
| NBB-400-T1 | Tape & Reel, 1000 Pieces |
| NBB-400-D | NBB-400 Chip Form (100 pieces minimum order) |
| NBB-400-E | Fully Assembled Evaluation Board |
| NBB-X-K1 | Extended Frequency InGaP Amp Designer's Tool Kit |

RF Micro Devices, Inc. Tel (336) 664 1233
7628 Thorndike Road Fax (336) 664 0454
Greensboro, NC 27409, USA <http://www.rfmd.com>

NBB-400

Absolute Maximum Ratings

| Parameter | Rating | Unit |
|-----------------------|-------------|------|
| RF Input Power | +20 | dBm |
| Power Dissipation | 300 | mW |
| Device Current | 70 | mA |
| Channel Temperature | 200 | °C |
| Operating Temperature | -45 to +85 | °C |
| Storage Temperature | -65 to +150 | °C |

Exceeding any one or a combination of these limits may cause permanent damage.



Caution! ESD sensitive device.

RF Micro Devices believes the furnished information is correct and accurate at the time of this printing. RoHS marking based on EUDirective2002/95/EC (at time of this printing). However, RF Micro Devices reserves the right to make changes to its products without notice. RF Micro Devices does not assume responsibility for the use of the described product(s).

| Parameter | Specification | | | Unit | Condition |
|---|---------------|------------|------|-------|---|
| | Min. | Typ. | Max. | | |
| Overall | | | | | $V_D=+3.9V, I_{CC}=47mA, Z_0=50\Omega, T_A=+25^\circ C$ |
| Small Signal Power Gain, S21 | 15.5 | 16.7 | | dB | f=0.1GHz to 1.0GHz |
| | | 16.5 | | dB | f=1.0GHz to 4.0GHz |
| | | 16.0 | | dB | f=4.0GHz to 6.0GHz |
| | 12.5 | 13.5 | | dB | f=6.0GHz to 8.0GHz |
| Gain Flatness, GF | | ±0.8 | | dB | f=0.1GHz to 5.0GHz |
| Input and Output VSWR | | 1.45:1 | | | f=0.1GHz to 4.0GHz |
| | | 1.30:1 | | | f=4.0GHz to 6.0GHz |
| | | 1.90:1 | | | f=6.0GHz to 12.0GHz |
| Bandwidth, BW | | 7.5 | | GHz | BW3 (3dB) |
| Output Power @ -1dB Compression, P1dB | | 13.0 | | dBm | f=2.0GHz |
| | | 14.6 | | dBm | f=6.0GHz |
| | | 13.5 | | dBm | f=9.0GHz |
| Noise Figure, NF | | 4.3 | | dB | f=3.0GHz |
| Third Order Intercept, IP3 | | +28.1 | | dBm | f=2.0GHz |
| Reverse Isolation, S12 | | -17.5 | | dB | f=0.1GHz to 12.0GHz |
| Device Voltage, V_D | 3.6 | 3.9 | 4.2 | V | |
| Gain Temperature Coefficient, $\delta G_T/\delta T$ | | -0.0015 | | dB/°C | |
| MTTF versus Temperature @ $I_{CC}=50mA$ | | | | | |
| Case Temperature | | 85 | | °C | |
| Junction Temperature | | 131 | | °C | |
| MTTF | | >1,000,000 | | hours | |
| Thermal Resistance | | | | | |
| θ_{JC} | | 251 | | °C/W | $\frac{J_T - T_{CASE}}{V_D \cdot I_{CC}} = \theta_{JC} (^\circ C/Watt)$ |

| Pin | Function | Description | Interface Schematic |
|-----|----------|---|---------------------|
| 1 | RF IN | RF input pin. This pin is NOT internally DC blocked. A DC blocking capacitor, suitable for the frequency of operation, should be used in most applications. DC coupling of the input is not allowed, because this will override the internal feedback loop and cause temperature instability. | |
| 2 | GND | Ground connection. For best performance, keep traces physically short and connect immediately to ground plane. | |
| 3 | RF OUT | <p>RF output and bias pin. Biasing is accomplished with an external series resistor and choke inductor to V_{CC}. The resistor is selected to set the DC current into this pin to a desired level. The resistor value is determined by the following equation:</p> $R = \frac{(V_{CC} - V_{DEVICE})}{I_{CC}}$ <p>Care should also be taken in the resistor selection to ensure that the current into the part never exceeds maximum datasheet operating current over the planned operating temperature. This means that a resistor between the supply and this pin is always required, even if a supply near 5.0V is available, to provide DC feedback to prevent thermal runaway. Because DC is present on this pin, a DC blocking capacitor, suitable for the frequency of operation, should be used in most applications. The supply side of the bias network should also be well bypassed.</p> | |
| 4 | GND | Same as pin 2. | |

NBB-400

Typical Bias Configuration

Application notes related to biasing circuit, device footprint, and thermal considerations are available on request.

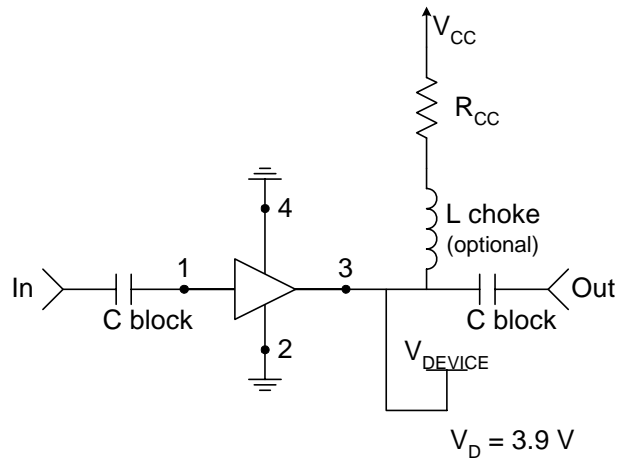

| Recommended Bias Resistor Values | | | | | | |
|--------------------------------------|----|----|-----|-----|-----|-----|
| Supply Voltage, V_{CC} (V) | 5 | 8 | 10 | 12 | 15 | 20 |
| Bias Resistor, R_{CC} (Ω) | 22 | 81 | 122 | 162 | 222 | 322 |

Chip Outline Drawing - NBB-400-D

Chip Dimensions: 0.017" x 0.017" x 0.004"

UNITS:

Inches
(mm)

Back of chip is ground.

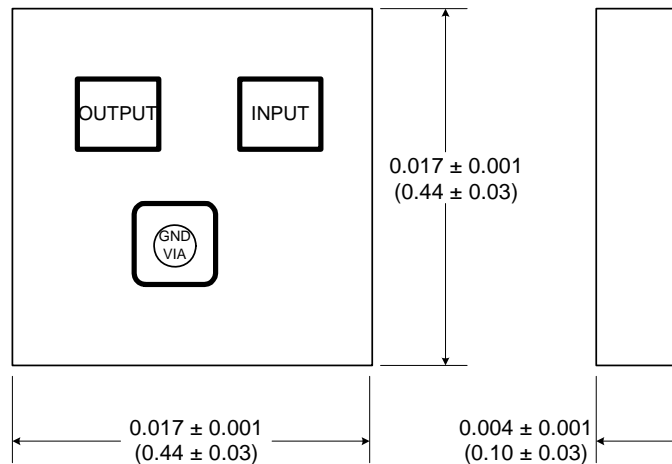

Sales Criteria - Unpackaged Die

Die Sales Information

- All segmented die are sold 100% DC-tested. Testing parameters for wafer-level sales of die material shall be negotiated on a case-by-case basis.
- Segmented die are selected for customer shipment in accordance with RFMD Document #6000152 - Die Product Final Visual Inspection Criteria¹.
- Segmented die has a minimum sales volume of 100 pieces per order. A maximum of 400 die per carrier is allowable.

Die Packaging

- All die are packaged in GelPak ESD protective containers with the following specification: O.D.=2" X2", Capacity=400 Die (20X20 segments), Retention Level=High(X0).
- GelPak ESD protective containers are placed in a static shield bag. RFMD recommends that once the bag is opened the GelPak/s should be stored in a controlled nitrogen environment. Do not press on the cover of a closed GelPak, handle by the edges only. Do not vacuum seal bags containing GelPak containers.
- Precaution must be taken to minimize vibration of packaging during handling, as die can shift during transit².

Package Storage

- Unit packages should be kept in a dry nitrogen environment for optimal assembly, performance, and reliability.
- Precaution must be taken to minimize vibration of packaging during handling, as die can shift during transit².

Die Handling

- Proper ESD precautions must be taken when handling die material.
- Die should be handled using vacuum pick-up equipment, or handled along the long side with a sharp pair of tweezers. Do not touch die with any part of the body.
- When using automated pick-up and placement equipment, ensure that force impact is set correctly. Excessive force may damage GaAs devices.

Die Attach

- The die attach process mechanically attaches the die to the circuit substrate. In addition, the utilization of proper die attach processes electrically connect the ground to the trace on which the chip is mounted. It also establishes the thermal path by which heat can leave the chip.
- Die should be mounted to a clean, flat surface. Epoxy or eutectic die attach are both acceptable attachment methods. Top and bottom metallization are gold. Conductive silver-filled epoxies are recommended. This procedure involves the use of epoxy to form a joint between the backside gold of the chip and the metallized area of the substrate.
- All connections should be made on the topside of the die. It is essential to performance that the backside be well grounded and that the length of topside interconnects be minimized.
- Some die utilize vias for effective grounding. Care must be exercised when mounting die to preclude excess run-out on the topside.

Die Wire Bonding

- Electrical connections to the chip are made through wire bonds. Either wedge or ball bonding methods are acceptable practices for wire bonding.
- All bond wires should be made as short as possible.

Notes

¹RFMD Document #6000152 - Die Product Final Visual Inspection Criteria. This document provides guidance for die inspection personnel to determine final visual acceptance of die product prior to shipping to customers.

²RFMD takes precautions to ensure that die product is shipped in accordance with quality standards established to minimize material shift. However, due to the physical size of die-level product, RFMD does not guarantee that material will not shift during transit, especially under extreme handling circumstances. Product replacement due to material shift will be at the discretion of RFMD.

Extended Frequency InGaP Amplifier Designer's Tool Kit NBB-X-K1

This tool kit was created to assist in the design-in of the RFMD NBB- and NLB-series InGaP HBT gain block amplifiers. Each tool kit contains the following.

- 5 each NBB-300, NBB-310 and NBB-400 Ceramic Micro-X Amplifiers
- 5 each NLB-300, NLB-310 and NLB-400 Plastic Micro-X Amplifiers
- 2 Broadband Evaluation Boards and High Frequency SMA Connectors
- Broadband Bias Instructions and Specification Summary Index for ease of operation

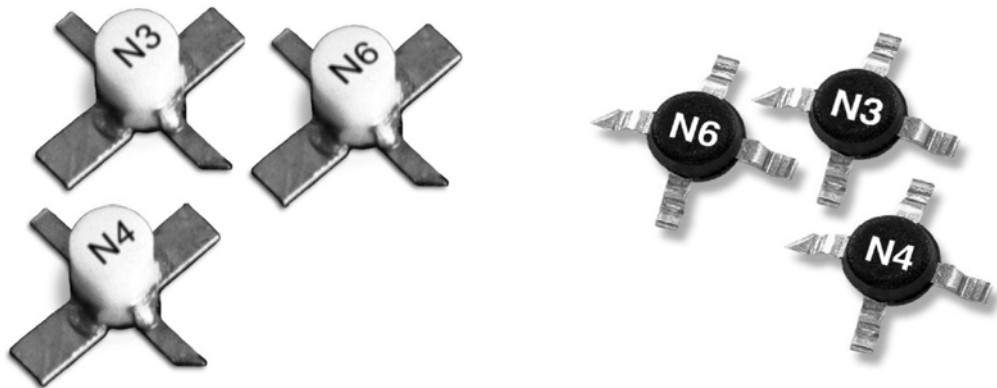

Device Voltage versus Amplifier Current

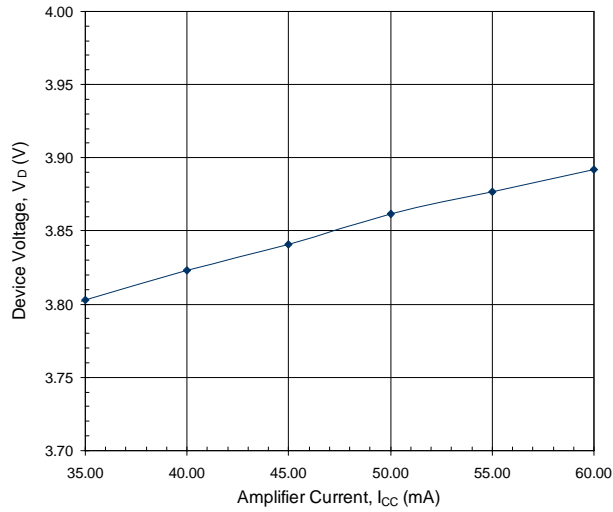

P1dB versus Frequency

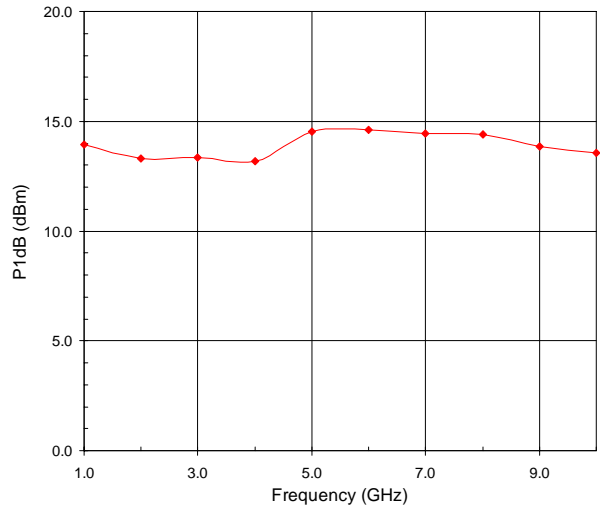

P_{OUT}/Gain versus P_{IN} at 2 GHz

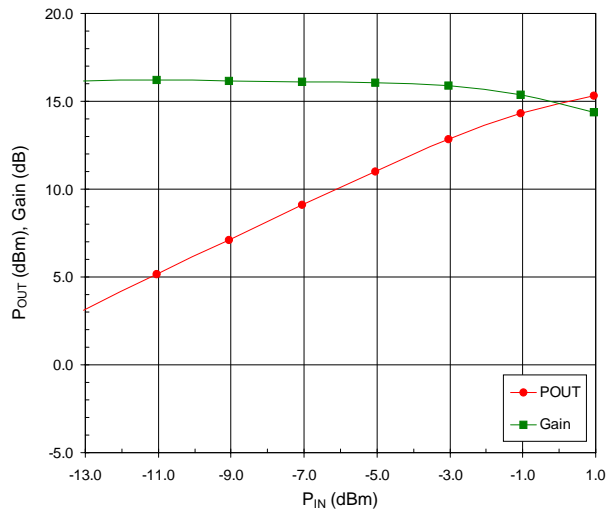

P_{OUT}/Gain versus P_{IN} at 6 GHz

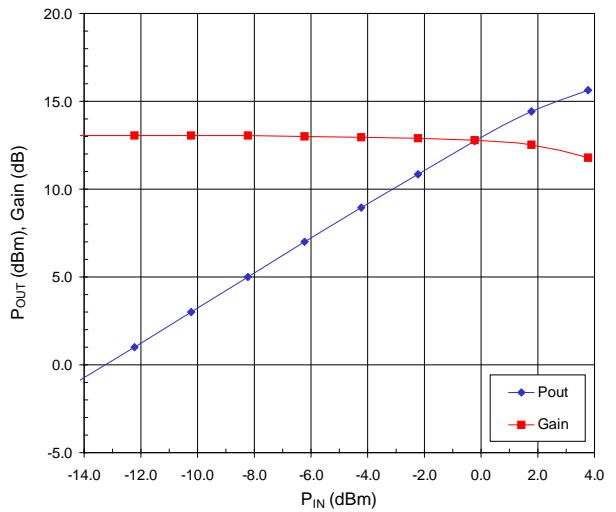

Third Order Intercept versus Frequency

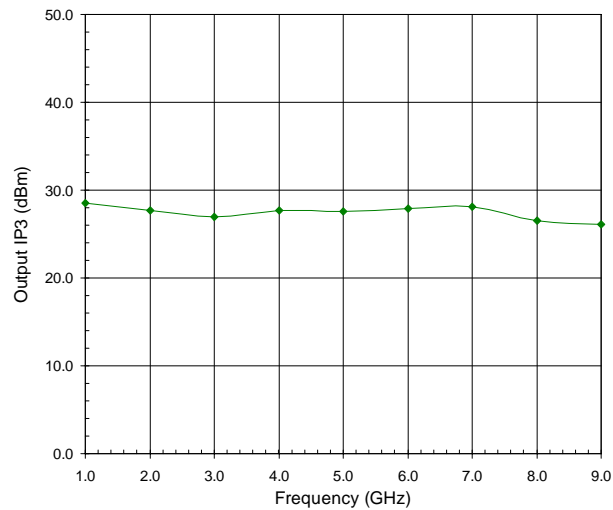

NBB-400

Note: The s-parameter gain results shown below include device performance as well as evaluation board and connector loss variations. The insertion losses of the evaluation board and connectors are as follows:

- 1 GHz to 4GHz=-0.06dB
- 5GHz to 9GHz=-0.22dB
- 10GHz to 14GHz=-0.50dB
- 15GHz to 20GHz=-1.08dB

S11 versus Frequency, Over Temperature

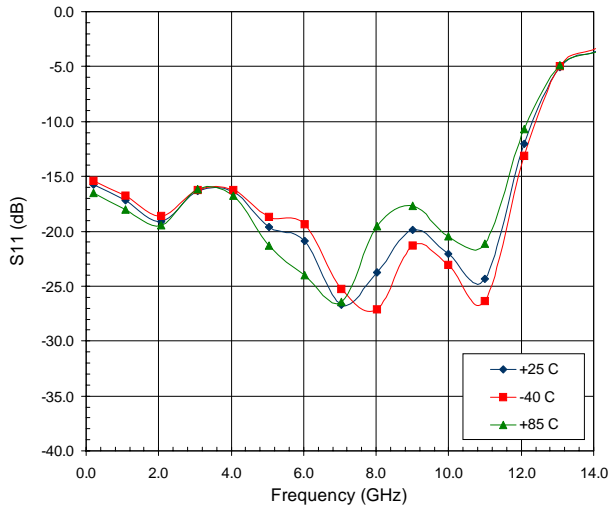

S12 versus Frequency, Over Temperature

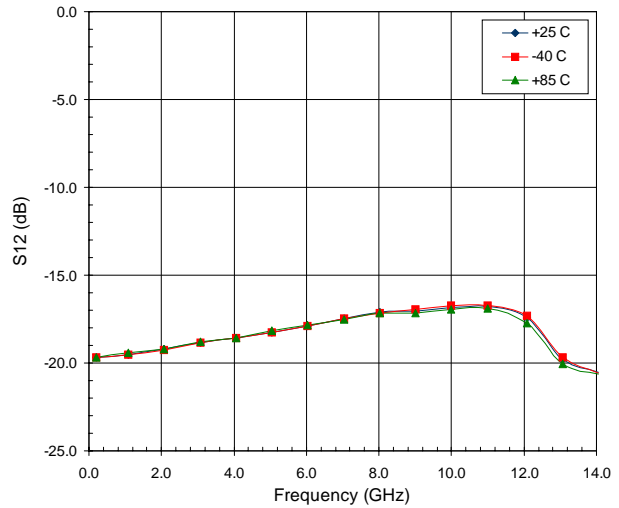

S21 versus Frequency, Over Temperature

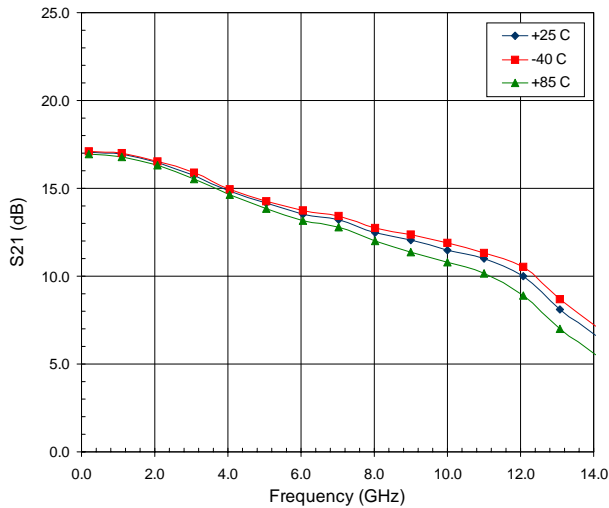

S22 versus Frequency, Over Temperature

