

New



Compliance with RoHS Directive

FEATURES

- **Ideal relay for high output 3-phase motors (EPS)**
2-path cutoff (2 Form A) using single coil for 3-phase motors
- **High current cutoff**
High current cutoff performance (12V) using 2-point cutoff configuration
- **High carrying current performance**
High capacity achieved through use of high conductivity material
- **Highly heat resistance properties**
High heat resistance (at 125°C 257°F) through use of high heat resistance plastic

TYPICAL APPLICATIONS

- To 3-phase motor EPS unit (for failsafe circuit)

ORDERING INFORMATION

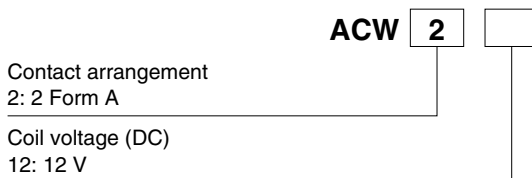

TYPES

Contact arrangement	Coil voltage	Part No.
2 Form A	12 V DC	ACW212

Standard packing; Carton: 40 pcs.; Case: 160 pcs.

RATING

1. Coil data

Nominal coil voltage	Pick-up voltage (at 20°C 68°F)	Drop-out voltage (at 20°C 68°F)	Nominal operating current [±10%] (at 20°C 68°F)	Coil resistance [±10%] (at 20°C 68°F)	Nominal operating power (at 20°C 68°F)	Usable voltage range
12V DC	Max. 6.2 V DC (Initial)	Min. 0.5 V DC (Initial)	117 mA	103Ω	1.4 W	10 to 16V DC

CW (ACW)

2. Specifications

Characteristics	Item	Specifications	
Contact	Arrangement	2 Form A	
	Contact resistance (Initial)	Max. 50 mΩ (By voltage drop 6V DC 1A)	
	Contact material	Ag alloy (Cadmium free)	
Rating	Nominal switching capacity (at carrying current)	120 A 14V DC for 5 seconds (at 20°C 68°F)	
		70 A 14V DC for 1 minute (at 85°C 185°F)	
		45 A 14V DC for continuous (at 85°C 185°F)	
	Nominal operating power	1.4 W	
Electrical characteristics	Min. switching capacity (resistive load)	1 A 14V DC (at 20°C 68°F)	
	Insulation resistance (Initial)		Min. 100 MΩ (at 500V DC)
	Breakdown voltage (Initial)	Between open contacts	500 Vrms for 1 min. (Detection current: 10mA)
		Between contacts and coil	500 Vrms for 1 min. (Detection current: 10mA)
	Operate time (at nominal voltage)		Max. 20ms (at 20°C 68°F, excluding contact bounce time) (Initial)
	Release time (at nominal voltage)		Max. 20ms (at 20°C 68°F) (Initial) (without protective element)
Mechanical characteristics	Shock resistance	Functional	Min. 200 m/s ² (approx. 20G) (Half-wave pulse of sine wave: 11ms; detection time: 10μs) (12 V DC applied to the coil, at 20°C 68°F)
		Destructive	Min. 1,000 m/s ² (approx. 100G) (Half-wave pulse of sine wave: 6ms)
	Vibration resistance	Functional	10 Hz to 500 Hz, Min. 44.1 m/s ² (approx. 4.5G) (Detection time: 10μs) (12 V DC applied to the coil, at 20°C 68°F)
		Destructive	10 Hz to 500 Hz, Min. 44.1 m/s ² (approx. 4.5G), Time of vibration for each direction; X, Y, Z direction: 4 hours
Expected life	Mechanical	Min. 2 × 10 ⁵ (at 60 cpm)	
	Electrical (at cut off only)	200 A 14V DC (resistive load), Min. 3 times (without diode)	
Conditions	Conditions for operation, transport and storage*	Ambient temperature: -40°C to +125°C -40°F to +257°F, Humidity: 5% R.H. to 85% R.H. (Not freezing and condensing at low temperature)	
Mass		Approx. 26 g .92 oz	

Note: * The upper operation ambient temperature limit is the maximum temperature that can satisfy the coil temperature rise value. Please refer to "Usage ambient condition" in CAUTIONS FOR USE OF AUTOMOTIVE RELAYS.

REFERENCE DATA

1.-(1) Coil temperature rise (25°C 77°F)

Sample: ACW212, 3pcs
Point measured: Inside the coil
Contact carrying current: 45A
Ambient temperature: 25°C 77°F

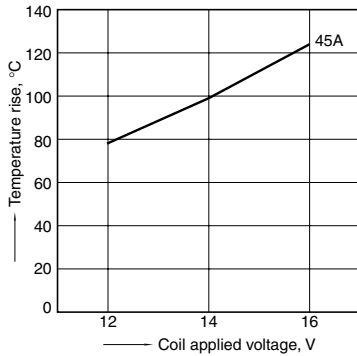

1.-(1) Coil temperature rise (85°C 185°F)

Sample: ACW212, 3pcs
Point measured: Inside the coil
Contact carrying current: 45A
Ambient temperature: 85°C 185°F

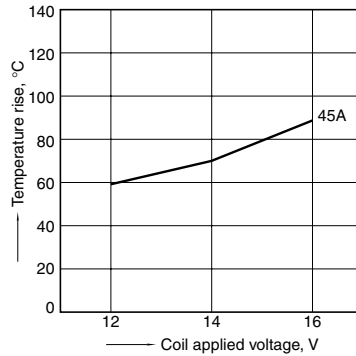

2. Distribution of pick-up and drop-out voltage

Sample: ACW212, 100pcs

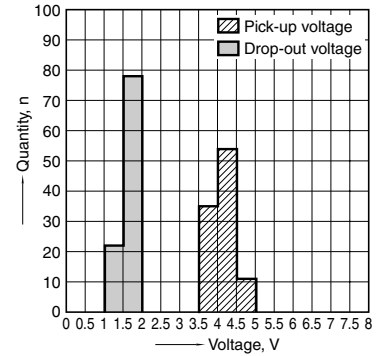

3. Distribution of operate and release time

Sample: ACW212, 100pcs.

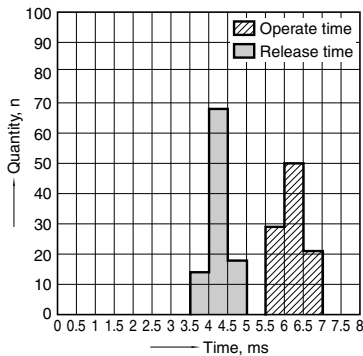

4. Ambient temperature and operating voltage range

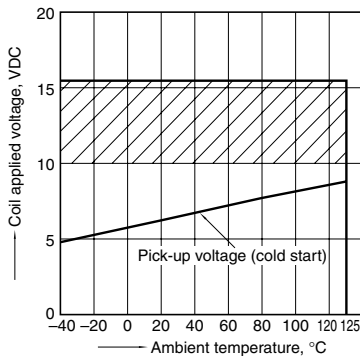

DIMENSIONS (mm inch)

The CAD data of the products with a **CAD Data** mark can be downloaded from: <http://panasonic-electric-works.net/ac>

CAD Data

External dimensions

Schematic (Bottom view)

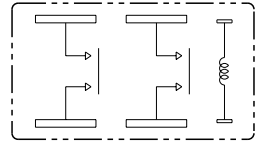
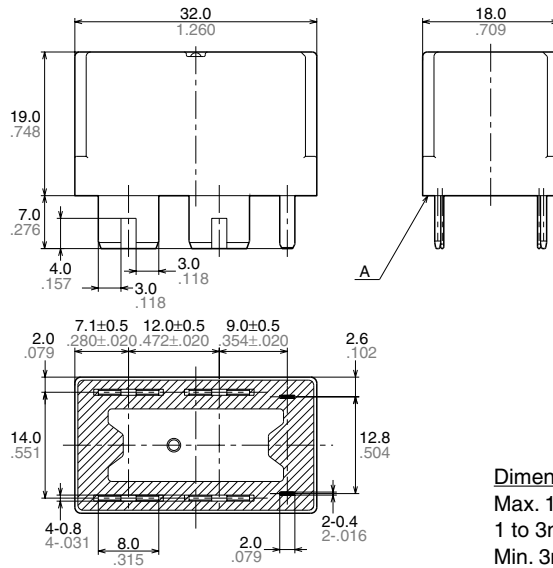

Dimension:	Tolerance
Max. 1mm .039 inch:	±0.1 ±.004
1 to 3mm .039 to .118 inch:	±0.2 ±.008
Min. 3mm .118 inch:	±0.3 ±.012

* Intervals between terminals is measured at A surface level.

For Cautions for Use, see Relay Technical Information.